

HOW TO ASSEMBLY YOUR FAIRY LIGHT PROJECT

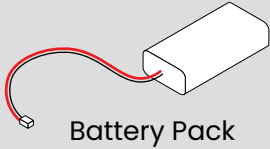

Includes:



Battery Pack

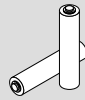

Batteries

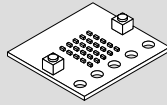

micro:bit

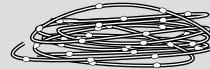

Neopixel Ring



Alligator Clips

- 1 Connect your micro:bit to the battery pack (refer to the How to Attach micro:bit to Battery Instructions).

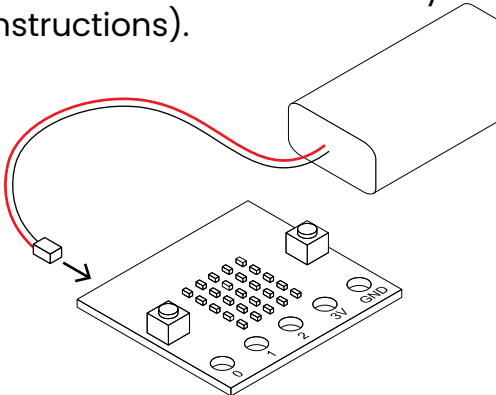

- 2 Connect your alligator clips to the fairy lights using the rectangular black box at one end. The colours of the wires connecting should match.

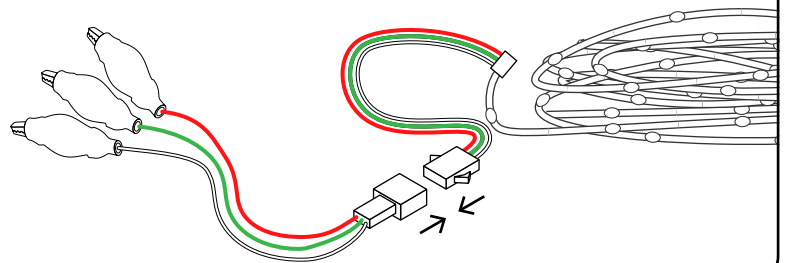

- 3 Connect the white wire to GND, the red wire connects to the 3v pin and the green wire connects to pin 0.

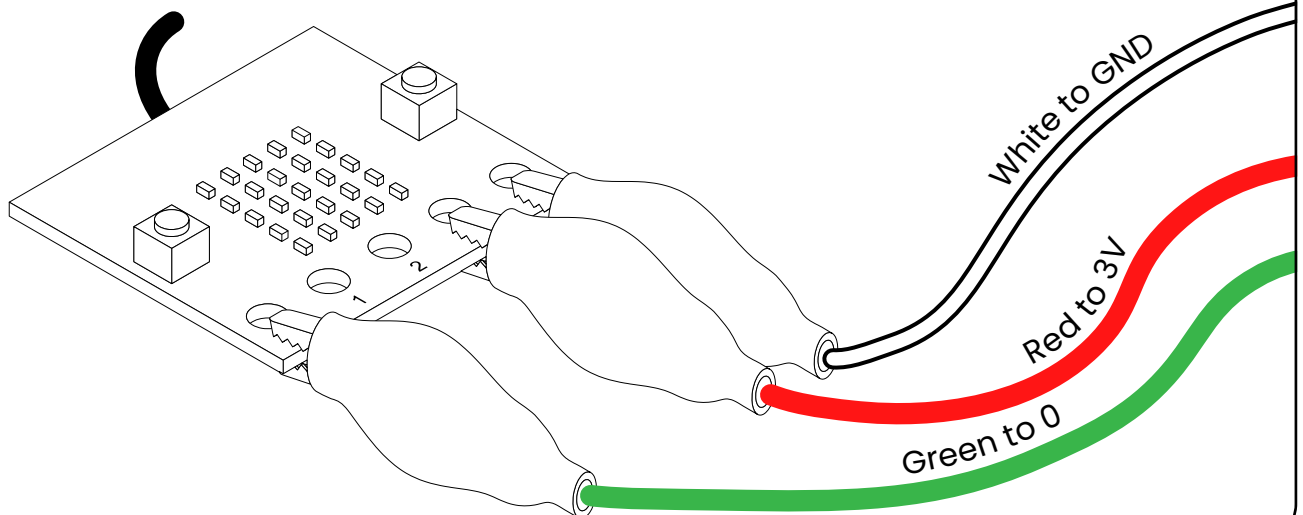

HOW TO ASSEMBLY YOUR FAIRY LIGHT PROJECT



4 Insert your micro:bit below. Fold the bottom flaps to secure the micro:bit.

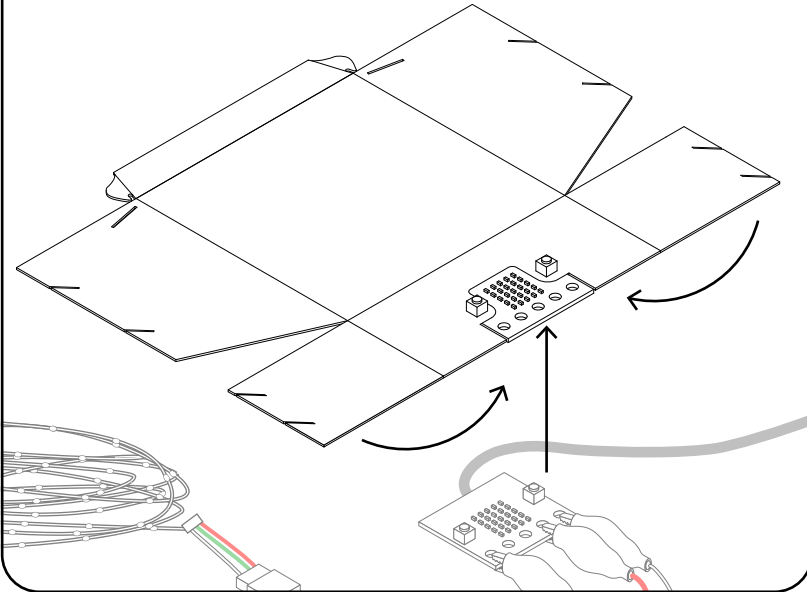

5 Fold the side flaps back so they can be used as a stand.

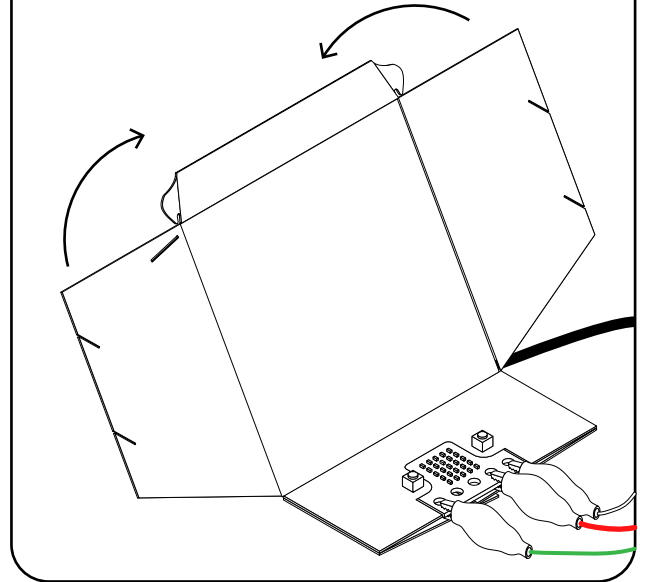

6 Fold the top flap back and insert the tabs into the slots on the sides to secure them all together.

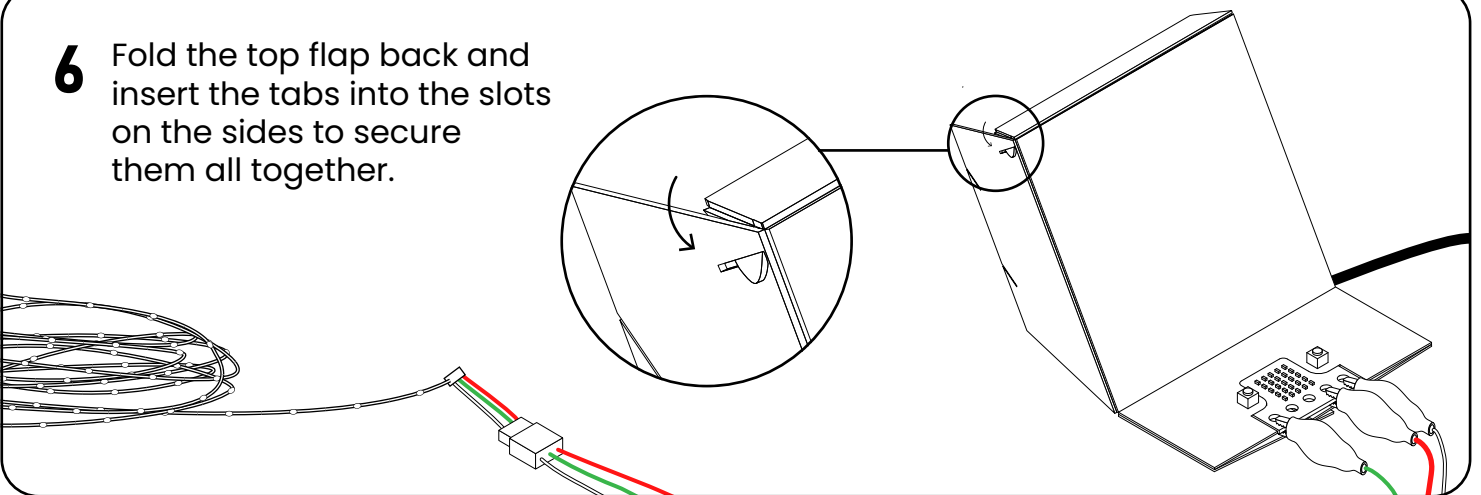

Presented by:

